

MC 175 B

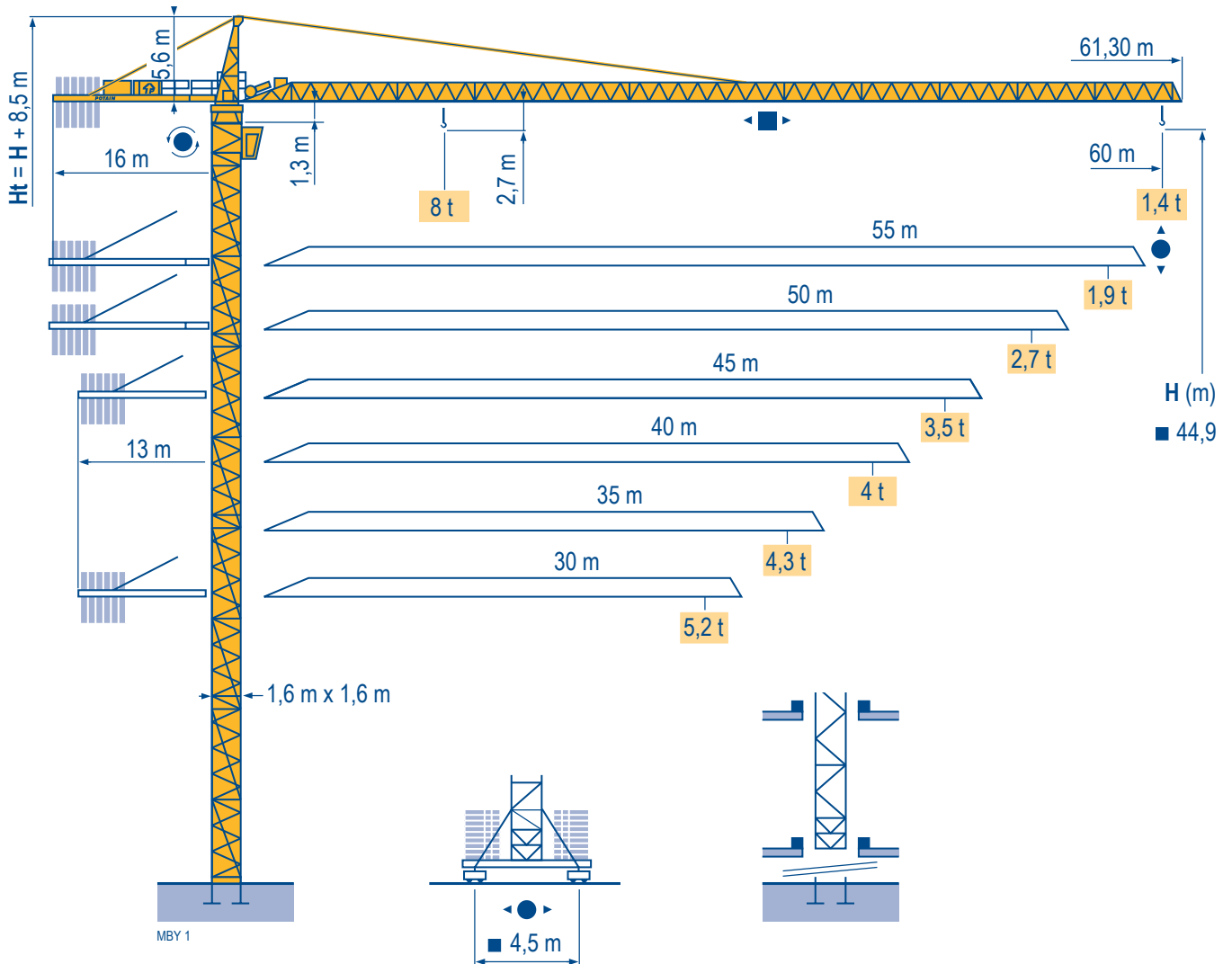

Masts / Reactions

□ 1,6 m
 ▣ 30 m → 60 m

MBY 1

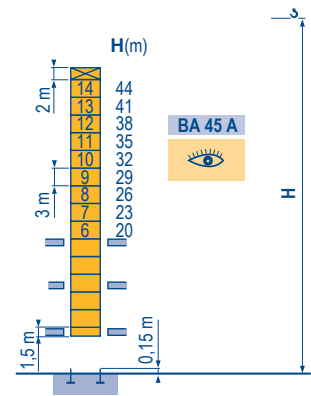
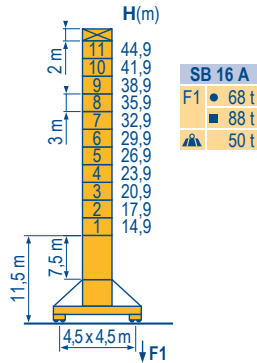
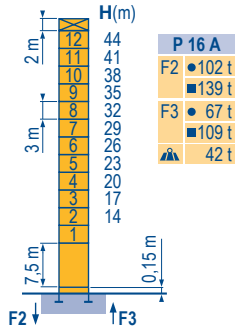

Climbing crane

MBY 1

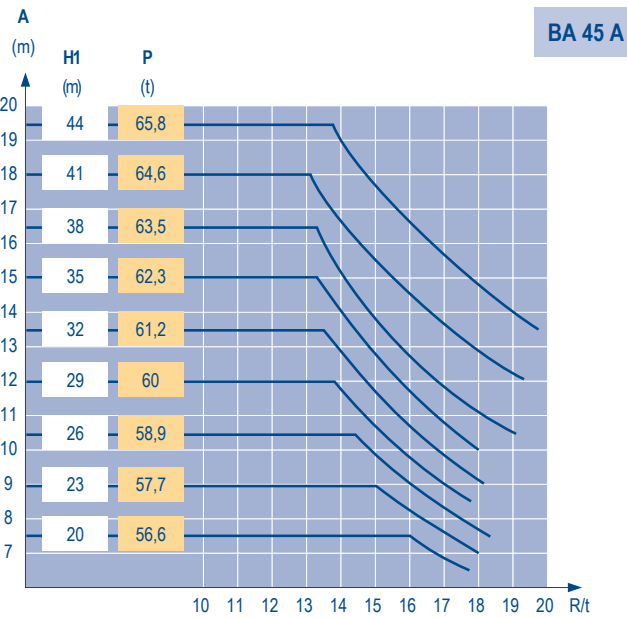
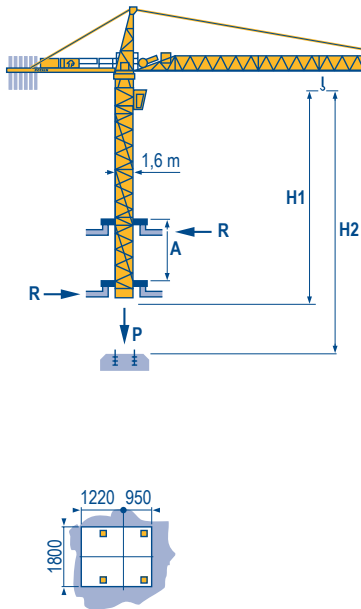

CITY CRANE MC 175 B



GB

- Reactions in service
- Reactions out of service
- ▲ Without load, ballast (or transport axles), with maximum jib and maximum height.
- 👁 See climbing crane

Load diagrams

MBY 1

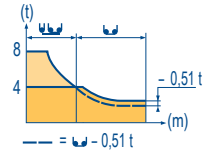
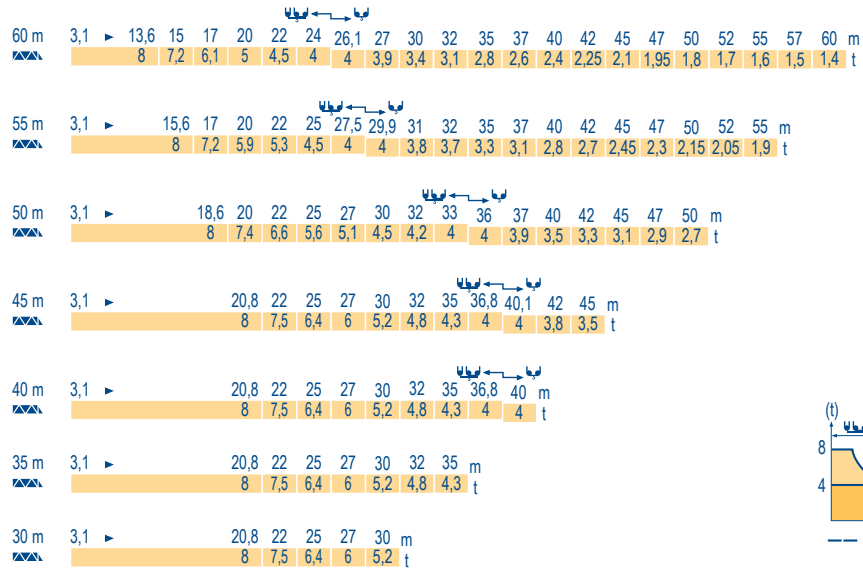

Counter-jib ballast

MBY 1

▲	▲	3450 kg	2250 kg	▲ (kg)
60 m	16 m	4	2	18 300
55 m	16 m	3	3	17 100
50 m	16 m	3	2	14 850
45 m	13 m	5	1	19 500
40 m	13 m	4	2	18 300
35 m	13 m	3	3	17 100
30 m	13 m	3	2	14 850

Base ballast

MBY 1

▣ 1,6 m	SB 16 A	H (m)	44,9	41,9	38,9	35,9	32,9	29,9	26,9	23,9	20,9	17,9	14,9
		▲ (t)	72	60	54	54	54	54	54	54	54	54	54

Anchorage

MBY 1

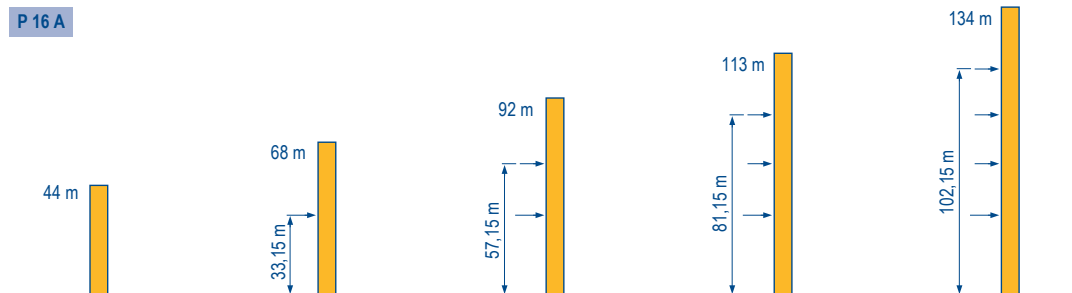

CITY CRANE MC 175 B

POTAIN

GB

- A Distance between collars
- H1 Crane height
- P Crane weight (in service)
- R Horizontal reaction

Mechanisms

MBY 2

							hp	kW						
	45 RCS 20	m/min	0 → 40	0 → 80	0 → 20	0 → 40	45	33	329 m					
		t	4	2	8	4								
	5 D3 V4	m/min	15 - 30 - 58				5	3,7						
	50 LVF 20 Optima	m/min	3,8 → 14,8 → 46 → 58 → 84 → 112	1,9 → 7,4 → 23 → 29 → 42 → 56		50	37	363 m						
		t	4	4	4	3	2	1	8	8	8	6	4	2
	6 DVF 4	m/min	0 - 6 → 76				5,5	4						
	RCV 145	rpm	0 → 0,8				2 x 6	2 x 4,4						
	SB 16 A RT 324 R ≥ 10 m	m/min	12,5 - 25				2 x 7	2 x 5,2						
CEI 38			IEC 38			kVA								
400 V (+6% -10%) 50 Hz			45 RCS : 60 kVA 50 LVF : 70 kVA											

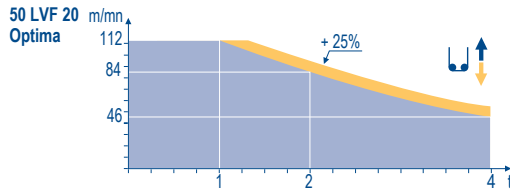

GB

-  Hoisting
-  Trolleying
-  Slewing
-  Travelling



This commercial document is not legally binding.
For any technical information, please refer to the corresponding instructions.



Americas
Tel : +1 888 479 7278
Tel : +1 717 593 2000

Europe - Middle East - Africa
Tel : +33 (0) 4 72 81 50 00
Tel : +44 (0) 191 522 2000

Asia - Pacific
Tel : +65 6264 1188
Fax : +65 6862 4040

www.manitowoccrane.com

Manitowoc Crane Group Asia Pte Ltd
Manitowoc Crane Group
4 Kwong Min Road
Singapore 628707
Tel: +65 6264 1188
Fax: +65 6862 4040
www.manitowoccrane.com

MC 175 B
Réf. 2004 45 MBY 3

Copyright.Reproduction interdite © POTAIN 2004

Réalisation Sedoc